

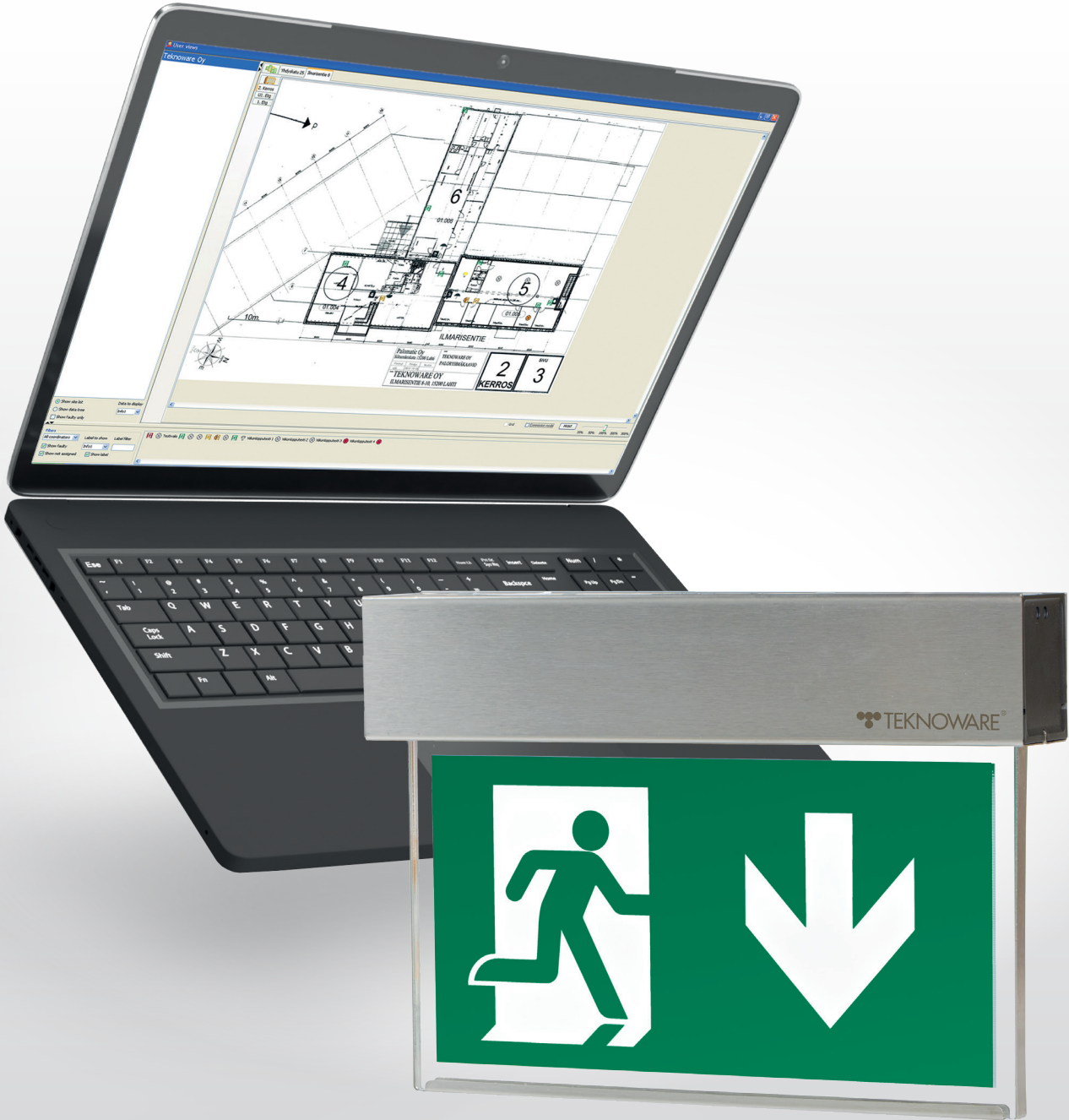

TEKNOWARE

AaltoCtrl



AaltoCtrl Remote monitoring system for self-contained emergency and exit lights



AaltoCtrl remote monitoring system for the monitoring of self-contained luminaires



AaltoCtrl remote monitoring system allows the wireless and centralised monitoring of self-contained luminaires. The system does not require a central battery unit or data cabling between the luminaires – the local power supply to the luminaires is sufficient. The emergency lighting system is easy and effortless to implement. You simply install the luminaires in place and the system is ready for use. The luminaires are easy to adapt and relocate if changes take place in the properties.

The AaltoCtrl system provides an alert if a luminaire fails and shows the tests conducted and the status of the luminaires. Notifications of system status and alerts can be subscribed via email. Adding more luminaires to the system is easy, making the AaltoCtrl system easy to expand and adapt. The arrangement of luminaires into groups by floor, building and other areas, for example, makes it easier to locate individual luminaires in large properties in particular. Permitted times for the automatic luminaire tests can be determined according to the needs of the property.

Since the network is created automatically, the system is easy to commission: Each self-contained luminaire in the system receives and transfers data, and the wireless AaltoCtrl-MESH network is created between the luminaires connected to mains power. If one luminaire drops off the network, the system finds a new route via the other luminaires. The luminaires are self-testing, independent devices. None of their safety features depend on the network operations. The signal passes through light partition walls and doors without problems and moves between floors. The range is up to 40 metres in open indoor spaces and up to 80 metres outdoors. A separate signal amplifier can be used to amplify the signal for unusually thick walls or other obstacles. The information about a failure in the system can be sent to other systems, such as building management systems, or relay controlled devices, via the alert relay output.

Either a separate AaltoCtrl WMU monitoring unit or the AaltoCtrl PC software is used for operating the remote monitoring system.

Wireless and centralised monitoring of the emergency lighting system

Wireless system

Enables wireless, centralised monitoring of self-contained luminaires. The system does not require a central battery unit or data cabling between the luminaires – the local power supply to the luminaires is sufficient.

An automatically created network

Each self-contained luminaire in the system receives and transfers data, and the wireless AaltoCtrl-MESH network is created between the luminaires connected to mains power. The range is up to 40 metres in open indoor spaces and up to 80 metres outdoors.

Centralised monitoring

The system provides an alert if a luminaire fails and shows the tests conducted and the status of the luminaires. The assignment of luminaires into groups enables locating individual luminaires in large properties in particular, and the times allowed for the automatic luminaire tests can be determined for each luminaire separately.

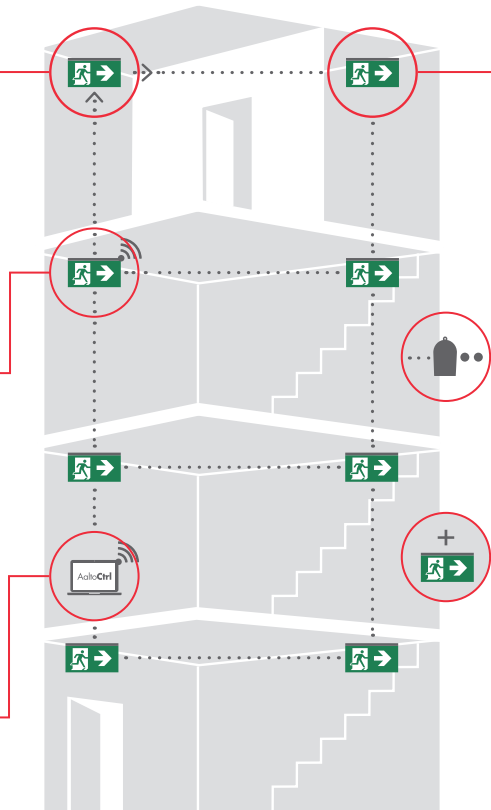

Strong signal

The signal passes through light partition walls and doors without problems and moves between floors. Emergency lights in the stairwell improve the transfer of the signal. The signal also passes through typical concrete structures when the luminaire in the next floor is placed directly above or under the luminaire.

Signal amplifier

A separate signal amplifier connected to mains power can be added to amplify the signal for unusually thick walls or other obstacles.

Adaptable

Adding more luminaires to the system is easy, making the system easy to expand and adapt. External AaltoCtrl coordinators can also be connected to the system to extend the network or divide it into separate sections, such as separate properties.



FEATURES

- Assignment of luminaires into groups by floor, building and other areas, for example.
- The luminaire type can be read automatically over the network.
- Monitoring of luminaire status and functionality.
- Collection of data of deviations and tests conducted.
- Possibility to receive status reports and alerts to email.
- The system includes several user levels, and different settings can be specified for different users.
- Luminaire data input from a CSV file, manually, using a barcode reader or using the automatic search functionality.
- Specifying time limits for the luminaire and duration tests.
- The alert relay output module allows transferring faults detected in the AaltoCtrl system to other systems or relay controlled devices. The alert relay output module is integrated in the WMU monitoring unit and is available as an accessory for the PC software.
- The luminaire test history can be stored on an USB device.

AaltoCtrl WMU

wireless monitoring unit

Touchscreen solution for local monitoring

AaltoCtrl WMU is a wall-mounted monitoring device for the AaltoCtrl system. The monitoring unit operates independently without a computer and can therefore be used in properties without a separate control room. The WMU allows the local monitoring of up to 500 luminaires, and the unit's 7-inch touchscreen makes it easy to use. The WMU has an integrated coordinator that is used for connecting to the AaltoCtrl network. An external coordinator can be used for connecting another AaltoCtrl network to the system, such as the network of an adjoining property. The AaltoCtrl WMU monitoring unit also includes an integrated alert relay output module which allows transferring fault indications to other systems or relay controlled devices.



For monitoring of self-contained luminaires, fixed wall mounting (for example, for properties without a separate control room).

Can be operated without a PC.

An integrated coordinator. One external coordinator can be added if the system needs to be expanded.

Thanks to integrated alert relay output, fault indication can be transferred from AaltoCtrl to other systems or relay-controlled devices.

An easy to use user interface with a 7" touchscreen.

Allows the local monitoring of up to 500 emergency exit lights and emergency lights.



HIGHLIGHTS



WALL MOUNTED,
FIXED



AN EASY TO USE
USER INTERFACE



NO PC NEEDED

max.

500

LUMINAIRES MONITORED
IN ONE SYSTEM

Product code	Product description
TST5108	AaltoCtrl WMU wireless monitoring unit (wall mounting)
TST5103	AaltoCtrl Ethernet coordinator (used when necessary)
TST5105	AaltoCtrl signal amplifier (used when necessary)

Further information on additional accessories p. 7

Technical data

Radio frequency	2.4 GHz
Range indoors	up to 40 m
Range outdoor/visual connection	up to 80 m

Wireless technology certificates

USA (FCC Part 15.247)
Industry Canada (IC)
Europe (CE) ETSI
RoHS compatible

Dimensions [mm]

TST5108

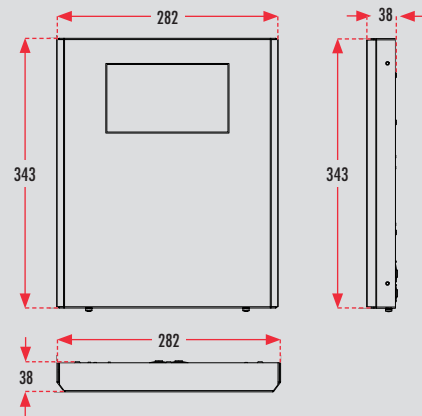

AaltoCtrl WMU system components

1. AaltoCtrl WMU basic system structure

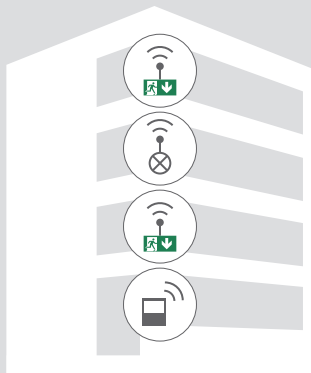

2. AaltoCtrl WMU + external coordinator

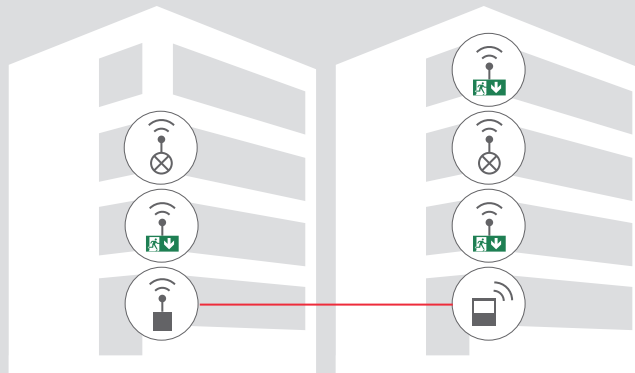

3. Internet connection

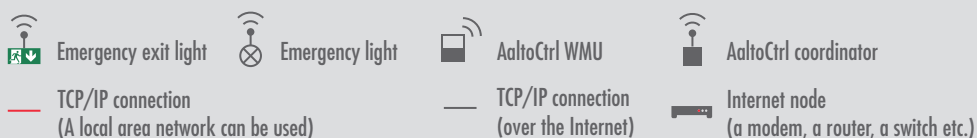
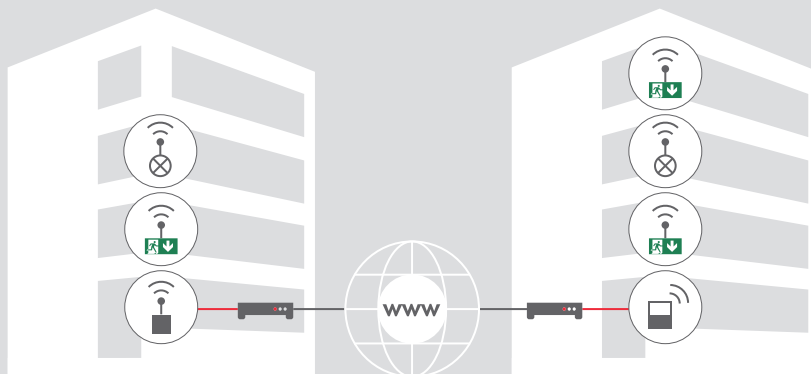

AaltoCtrl PC

Windows software

A versatile software for centralised monitoring

AaltoCtrl PC is a software suite installed on a computer allowing the centralised monitoring of up to 5,000 emergency exit lights and emergency lights connected to the AaltoCtrl system. The software comes with an easy to use graphical user interface. The floor plans of properties can be imported into the software, allowing the easy pinpointing of individual luminaires even in a large system simply by looking at the map.

The AaltoCtrl PC software is used via an external coordinator allowing the monitoring of up to 800 luminaires. Adding more coordinators expands the emergency lighting system to a monitoring system comprising up to 5,000 emergency exit lights and emergency lights. The computer used for monitoring and the coordinators can be placed freely into different rooms of single property or to different properties.



PC software for the monitoring of a self-contained luminaires (for large properties, for example).

Uses a PC and a coordinator (up to 800 luminaires/coordinator); up to 30 coordinators can be added to the system.

A clear graphical user interface and locations of luminaires marked in the floor plans.

Allows the local monitoring of up to 5,000 emergency exit lights and emergency lights.

An alert relay output module available as an accessory, allowing the transfer of fault indications in the AaltoCtrl system to other systems or relay controlled devices.



HIGHLIGHTS



WINDOWS
SOFTWARE



GRAPHICAL USER
INTERFACE



LOCATIONS OF LUMINAIRES
MARKED IN THE FLOOR PLANS

max.

5,000

LUMINAIRES MONITORED
IN ONE SYSTEM

Further information on additional accessories, p. 7

Product code	Product description
TST5103	AaltoCtrl Ethernet coordinator
TST5104C	AaltoCtrl V4 PC software (max. 5,000 luminaires)
TST5105	AaltoCtrl signal amplifier (used when necessary)
TST5107	AaltoCtrl emergency relay output module (allows the control of relay controlled devices, such as an alert device or a pilot light, through the AaltoCtrl system)

Technical data

Radio frequency	2.4 GHz
Range indoors	up to 40 m
Range outdoor/visual connection	up to 80 m

Wireless technology certificates

USA (FCC Part 15.247)
Industry Canada (IC)
Europe (CE) ETSI
RoHS compatible

AaltoCtrl PC system descriptions

1. A typical AaltoCtrl PC system description

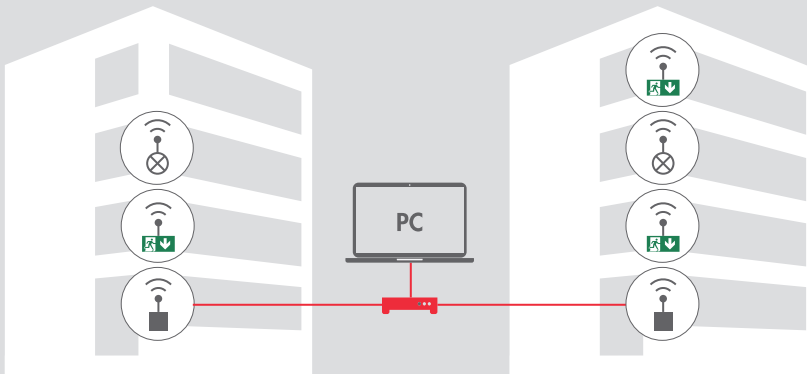

2. Using the AaltoCtrl PC system over the Internet

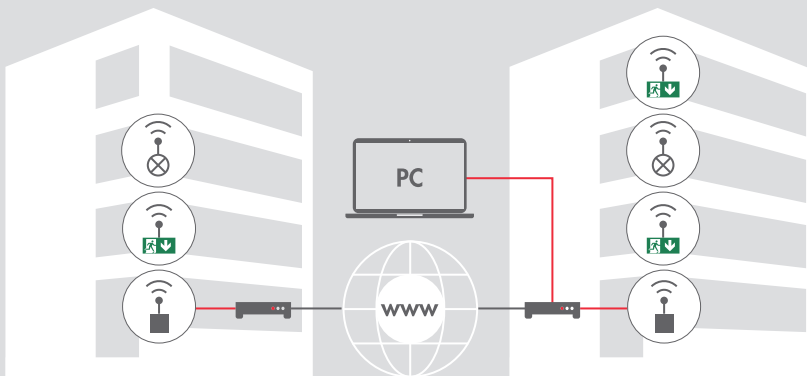

3. A coordinator connected directly to the computer

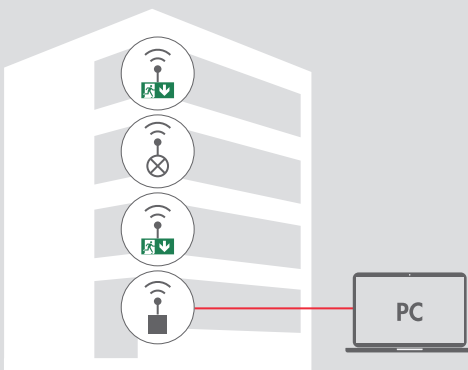

- Emergency exit light
- Emergency light
- AaltoCtrl coordinator
- TCP/IP connection (A local area network can be used)
- TCP/IP connection (over the Internet)
- Internet node (a modem, a router, a switch etc.)
- Switch/router

Additional AaltoCtrl modules

AaltoCtrl WMU

Optional accessory modules



Product code	Product description	
TST5103	AaltoCtrl Ethernet coordinator (used when necessary)	The AaltoCtrl WMU has an integrated coordinator that is used for connecting to the AaltoCtrl network. An external coordinator can be used for connecting another AaltoCtrl network to the system, such as the network of an adjoining property. The coordinator allows expanding the network to a separate area, for example.
TST5105	AaltoCtrl signal amplifier (used when necessary)	The signal amplifier connected to the AaltoCtrl network enhances the transfer of the signal in properties with exceptionally thick walls or other obstacles. The signal amplifier can also be used when the distances between the luminaires are long.

AaltoCtrl PC

An additional module needed for the AaltoCtrl PC software



Product code	Product description	
TST5103	AaltoCtrl Ethernet coordinator	<p>The AaltoCtrl PC software connects to the AaltoCtrl network through an external coordinator. One coordinator allows the monitoring of up to 800 luminaires. Adding more coordinators expands the emergency lighting system to one comprising up to 5,000 emergency exit lights and emergency lights.</p> <p>The coordinator can also be connected to the AaltoCtrl WMU monitoring unit if another AaltoCtrl emergency lighting system needs to be connected to the network.</p>

Optional accessory modules for the AaltoCtrl PC software



Product code	Product description	
TST5105	AaltoCtrl signal amplifier (used when necessary)	The signal amplifier connected to the AaltoCtrl network enhances the transfer of the signal in properties with exceptionally thick walls or other obstacles. The signal amplifier can also be used when the distances between the luminaires are long.
TST5107	AaltoCtrl emergency relay output module	The alert relay output module connected to the AaltoCtrl PC software allows transferring faults detected in the AaltoCtrl system to other systems, such as building automation systems, or relay controlled devices. All the luminaires or some luminaires of the property, such as the luminaires in one floor, can be specified for the relay output module. The AaltoCtrl WMU monitoring unit includes an integrated alert relay output module.

PAN-ID code

PAN-ID is used to lock AaltoCtrl luminaires to a specific network and allow them to communicate only with a corresponding AaltoCtrl coordinator. This is necessary when several AaltoCtrl networks and coordinators are used in the same area. If the property has an existing AaltoCtrl system and additional self-contained luminaires need to be added to it, inform us of the PAN-ID code of the existing network. We will add the correct PAN-ID codes to the new luminaires at the factory.

The PAN-ID code contains maximum four characters, and it comprises either letters (a-f) or numbers. The code can be 123F, for example. If no network-specific code is specified, the default code set at the factory is 5457. Three RF-ID/PAN-ID labels are sent with the luminaires. These should be attached to the outside of a recessed luminaire and in the building's drawings to indicate the location of the luminaire, when installing new luminaires.

RF-ID: 0013A20041D731A0 PAN-ID: 123F



LumiTest

AaltoCtrl luminaires always include the LumiTest self-testing feature. The LumiTest functionality monitors and tests the luminaires automatically and reliably.

Two indicator LEDs, one green and one red, indicate the status of the luminaire. A red LED indicates that the luminaire has a fault.

The operation of the luminaire and its light source are tested daily. The emergency duration time test is conducted every six months.

The product code of luminaires with the self-testing feature ends with "WA" or "WM".

LumiTest indicator LEDs *	
	No power
	Normal status
	Low charge
	Luminaire fault status
	Battery/capacitor fault status
	Battery/capacitor not connected
	Luminaire and battery/capacitor fault status
	Test in progress

* Applies to luminaires with two indicator LEDs.

Symbols	
	Blinking slowly (1 Hz, once a second)
	Blinking fast (2 Hz, twice a second)
	OFF
	ON



